

*digsy* fusion **S**  
**Safety Controller**

For use in mobile machines

## Structure image

*digsy*<sup>®</sup> fusion **S** is a versatile, modular controller. It can be individually fitted according to a modular design principle. To this end, the safety controller equipped with 48 I/Os and the communication interfaces provide the basis for each design variant. It can be extended by up to four I/O extensions with 48 I/Os each, thus resulting in a total of 240 safe or standard I/Os.

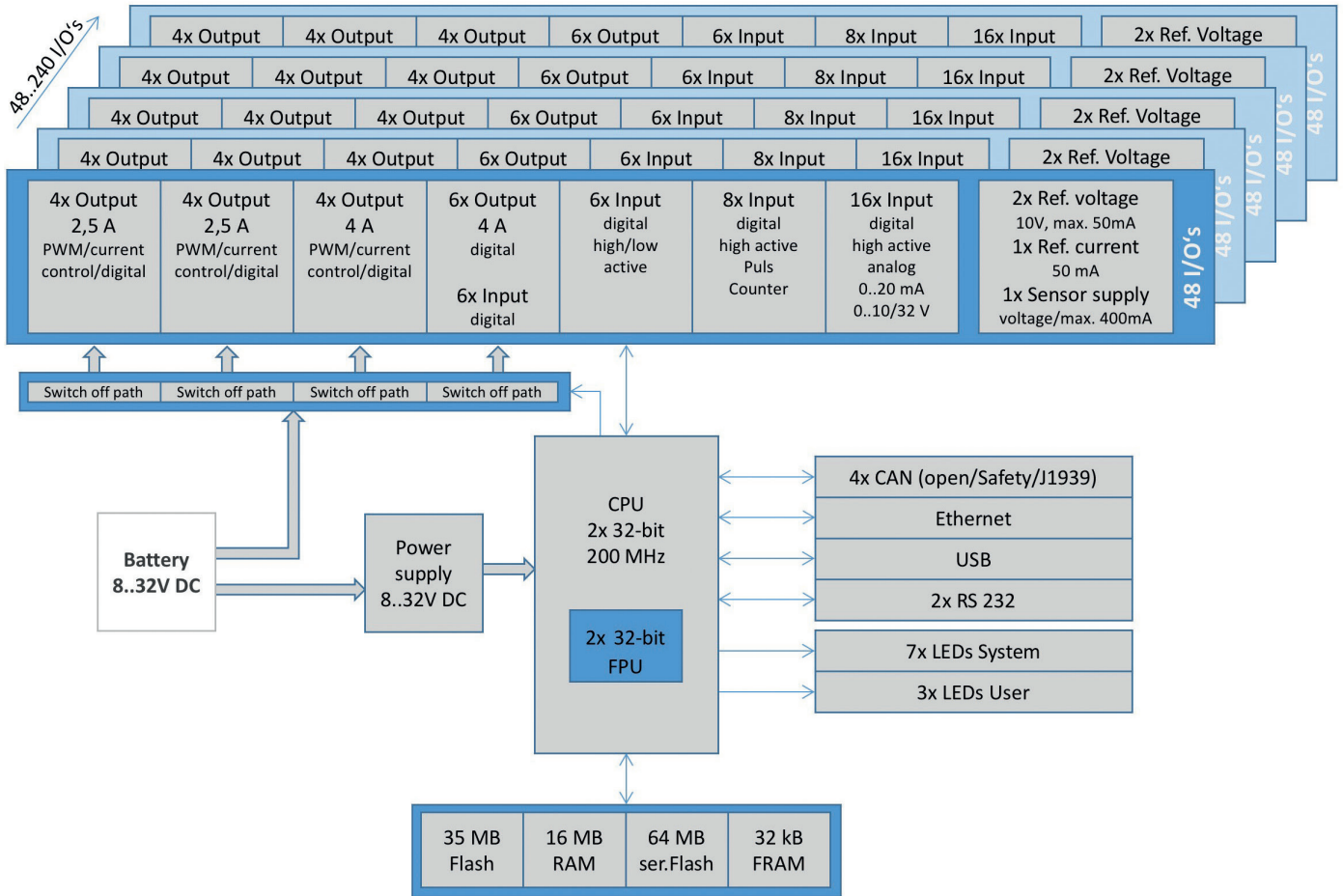

## Safety architecture

Depending on requirements defined by the applicable standards and the sensors used, both Cat. 2 and Cat. 3 architecture in accordance with EN/ISO 13849 can be implemented using *digsy*<sup>®</sup> fusion **S**. Since the features of the Dual Core processor are optimally used in each architecture, the computing power is mostly available to the user.

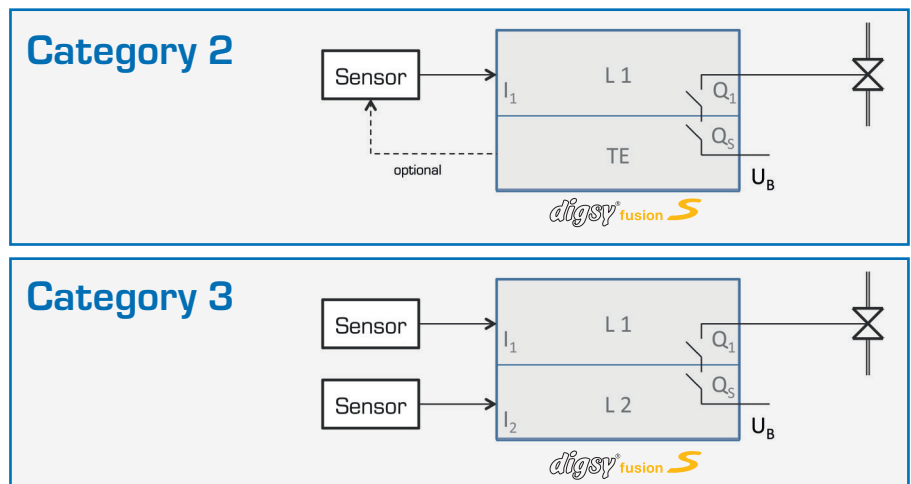



## Variable controller housing

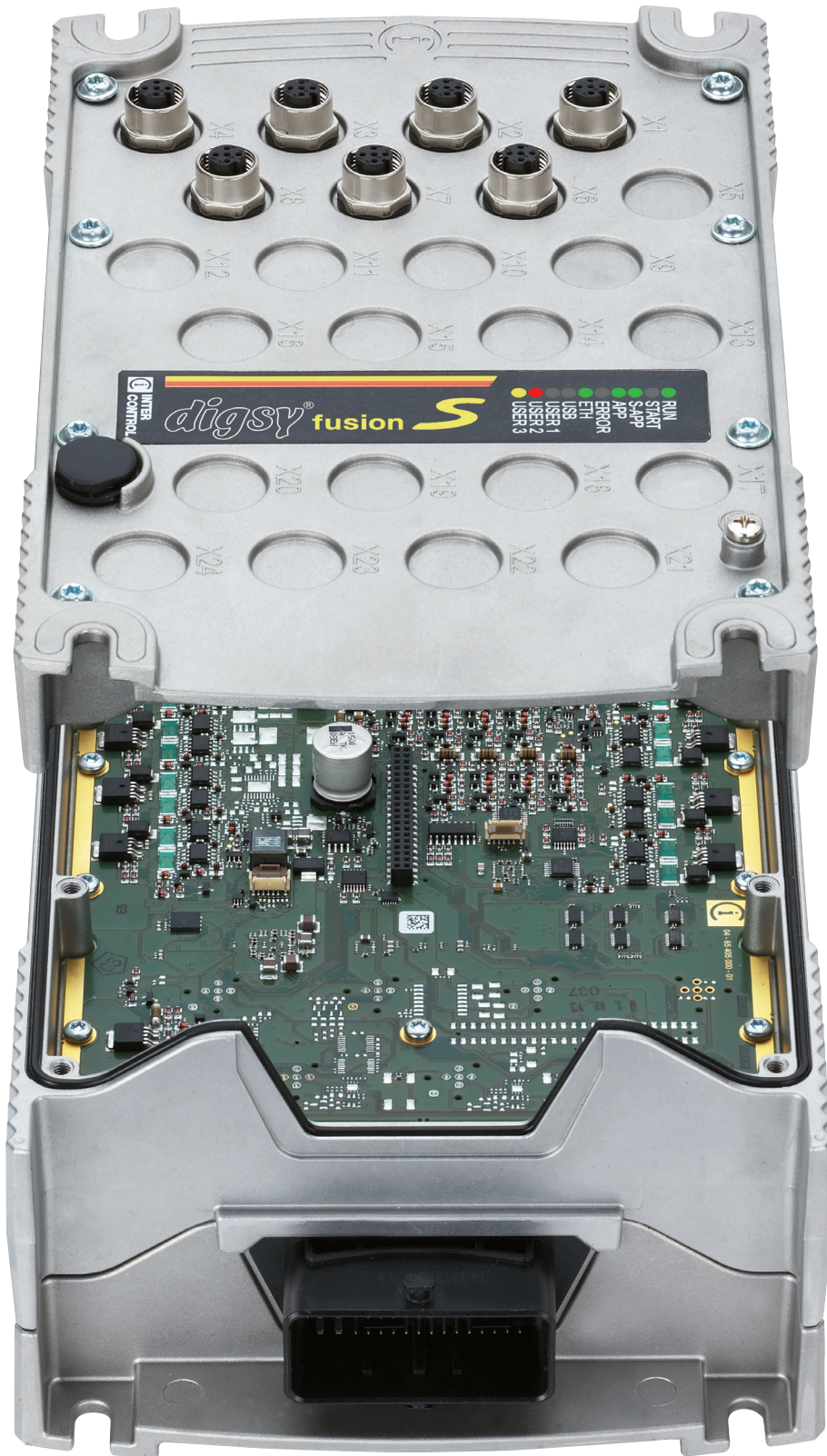

## Modular design principle



**Small housing variant:**  
 2 basic housing elements  
 1 controller module  
 1 extension module (optional)  
 48 to 96 I/Os



**Medium housing variant:**  
 2 basic housing elements  
 1 intermediate element  
 1 controller module  
 2 or 3 extension modules  
 144 to 192 I/Os



**Large housing variant:**  
 2 basic housing elements  
 2 intermediate elements  
 1 controller module  
 4 extension modules  
 240 I/Os

## Die cast metal housing for perfect protection

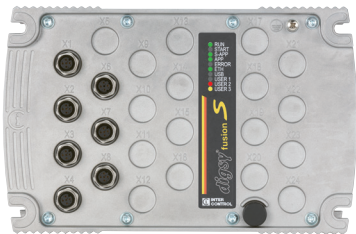

The robust *digsy<sup>®</sup> fusion S* housing was designed to withstand rough ambient conditions. The electronic system is therefore optimally protected against shock, vibration and even, to a certain extent, immersion. The sophisticated cooling concept enables operation in a wide temperature range.

The number of internal plug-and-socket connections was systematically reduced. The intelligent housing design allows various design variants suitable for any application on a compact footprint. A large number of LEDs provides comprehensive information on the various operating states.

## Variable cables and connections

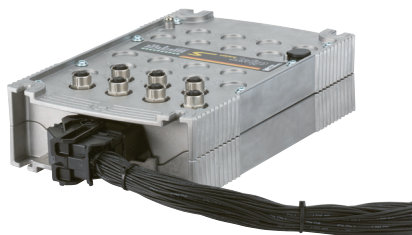

Connection of the I/Os, power supply and references via a lockable central plug with 64 pins of different ampacities.

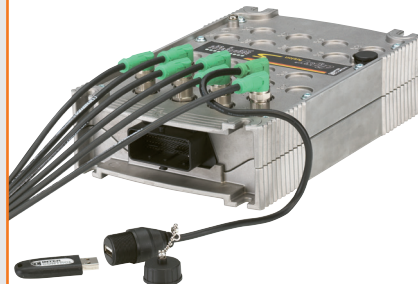

Connection of CAN bus, USB, Ethernet and RS232 via coded, shielded M12 connectors. For convenient access, the USB connector can be incorporated separately in the front panel.

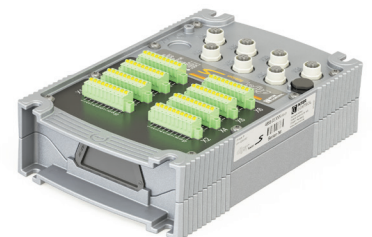

For example, connector block terminals can be implemented as a special solution.

## Safe into the future

As a second-generation safety controller *digisy*<sup>®</sup>**fusion S** complies with the latest requirements of the applicable safety standard EN/ISO 13849. It therefore enables the user to implement safety-relevant functions today for use on a long-term basis.



## The perfect solution for a wide spectrum of vehicles

Thanks to its scalability from 48 to 240 I/Os, a wide range of different vehicles can be automated using one single controller system – consistently and cost-effectively. The large number of safe inputs provides ideal prerequisites for meeting the requirements of redundantly implemented sensors in particular.

The modular structure of *digisy*<sup>®</sup>**fusion S** also provides options which go beyond mere I/O extensions. This ensures that future technologies can be applied later even though they are not yet relevant for the automation of mobile machines today.

## Subsequent customized adaptation of the machine

Due to the long service life of mobile machines, the possibility of subsequently adapting machines to ever changing market requirements is of primary importance. *digisy*<sup>®</sup>**fusion S** is the perfect solution because it supports the parallel processing of two programs implemented in the same controller. The first of these programs, referred to as the "safety program", serves for the safety functions, whereas the second, referred to as the "standard program", simultaneously processes e.g. comfort functions. The standard program thus operates without interference and does not influence the safety program. Changes and modifications to the standard program can be performed more quickly and without the need for conducting a comprehensive safety analysis.

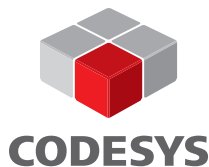

## Efficient support for the programmer

CODESYS 3.5 SIL2 makes the standard in mobile automation available to the programmer. The powerful programming environment provides efficient support especially for the implementation of safety-relevant functions. Both the safety program and the standard program are created consistently using the same programming environment. Tools, including the connection to Subversion or Static Code Analysis, provide the necessary frame conditions required to satisfy the needs of professionals.

## Unrestricted performance

Especially in case of demanding tasks, the performance of a safety controller must not be affected by internal tests and diagnoses. This is efficiently prevented through the use of a 32-bit Dual-Core safety processor operating in Lock-Step-Mode. The 200 MHz computing power is thus available to the user – almost without restriction.

In addition, a redundant FPU enables trigonometric calculations. The redundant CPU and FPU are managed internally in a manner not visible for the user. Just one safety program must be created.



J1939

CANopen



Ethernet

## Highly communicative

Based on Ethernet and USB, *digisy*<sup>®</sup>**fusion S** provides powerful interfaces which even transmit large data volumes within a very short time. This allows the convenient connection of laptops, modems or routers for the up- or download of application data or programs as well as the analysis of logging data. In addition, external mass storage units can be connected via the USB-interface. Four CAN bus interfaces are available for communication with sensors, CAN nodes or further controllers. These interfaces can be used with the CANopen, CANopen Safety and J1939 protocols or proprietary protocols prepared.

## Experience and know-how from an all-in-one solution provider

Thanks to its many decades of experience in the development and application of controllers, displays and nodes for mobile machines, Inter Control can offer support in the design and implementation of the perfect automation solution for your individual vehicle. We are looking forward to receiving your call.



# Technical Data

## Processor system

Processor:	32-bit Dual Core Controller, Lock-Step-Mode, 200 MHz, Floating-Point-Unit (FPU)
RAM:	16 MB – up to 4 MB available for variables
Flash:	35 MB – up to 2 MB available for the standard program – up to 1,5 MB available for the safety program – up to 16 MB available for the file system
Serial Flash:	64 MB for data logging
FRAM:	32 kB – 2x 8 kB available for safe retain data

## Inputs/outputs

12 type A outputs:	PWM, current-controlled / <b>SAFE</b> Digital output / <b>SAFE</b> 4 x 2.5 A 4 x 2.5 A 4 x 4.0 A
6 type B outputs:	Digital output / <b>SAFE</b> 6 x 4.0 A
6 type C inputs:	Digital input High active / <b>SAFE</b> Low active
8 type D inputs:	Digital input High active / <b>SAFE</b> Counting/pulse input / <b>SAFE</b> (via application)
16 type E inputs:	Digital input High active / <b>SAFE</b> Analog input / <b>SAFE</b> 0 to 20 mA 0 to 10 V 0 to 32 V
Outputs:	Overload-proof, short-circuit-proof

## Modular extension

Basic: 48 multi-functional I/Os, extendable to up to 240 I/Os

## Interfaces

CAN:	4 (CANopen, CANopen Safety, J1939, proprietary)
RS232:	2
Ethernet:	1 (UDP, TCP/IP)
USB:	1 (Host, V2.0)

## Connections

Central plug:	Supply voltages 48 inputs and outputs Reference voltages Reference currents
M12:	CAN RS232 Ethernet USB

## Reference/voltage outputs

1 sensor supply output:	Voltage output, switchable, following VIM, 400 mA overvoltage protection, short circuit protection
2 reference voltage outputs:	Voltage output, switchable, readback, 10 V (assembly option 8.2 V or 5 V), 50 mA, short circuit protection
1 reference current output:	Current output, switchable, 50 mA closed-loop controlled

## Safety

Requirements in acc. with EN/ISO 13849:	PL d, categories 2 and 3 Dual-channel design with cross checking TÜV-certified
Safe state:	De-energized state, i. e. shutdown of the machine
Safe shutdown:	Internally via 2nd shutdown path, divided into 4 blocks

## Programming

Programming:	CODESYS V3.5 SIL 2 TÜV-certified ST, FUP, LAD
Safety program:	1st application program
Standard program:	2nd application program
Programming system:	Consistent for standard and safe application program
Tasks:	Up to 3 cyclic tasks and one freewheeling task

## Outdoor properties

Protection class:	IP 6K7 / IP 6K9K
Ambient temperature:	-40 to +80 °C / -40 to 176 °F
Vibration resistance:	DIN EN 61131-2, DIN EN 60068-2-27, DIN EN 60068-2-64
Range of use:	Up to 4,000 m above sea level

## System data

Supply voltage:	8 V to 32 V DC
Status displays:	10 LEDs: 7 LEDs for system functions 3 LEDs programmable

## Mechanical data

Dimensions:	W x L x H (small housing): approx. 161.5 x 252 x 67 mm H (medium housing): approx. 114.4 mm H (large housing): approx. 161.6 mm
Housing:	Aluminum die casting with GORE-TEX® membrane for pressure compensation

## Inter Control

Hermann Köhler Elektrik GmbH & Co. KG  
Schafhofstraße 30  
D-90411 Nürnberg, Germany  
Fon +49(0)911 9522-5  
Fax +49(0)911 9522-857  
Email: info@intercontrol.de  
Internet: www.intercontrol.de

The properties mentioned in this brochure are not assured properties.  
Subject to technical change without prior notice.

Printed in Germany  
04-75070-030000

*Reliable Innovations*